

Original T-A Drill Inserts

1 Series | HSS | Diameter Range: 0.690" - 0.960" (17.53mm - 24.38mm)

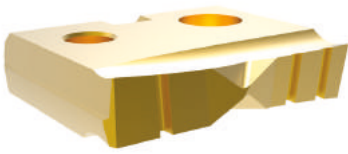

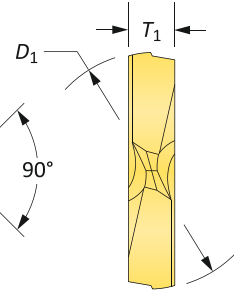
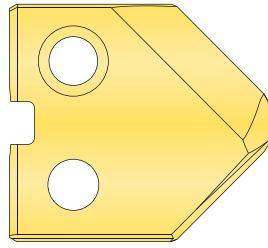

90° Spot & Chamfer

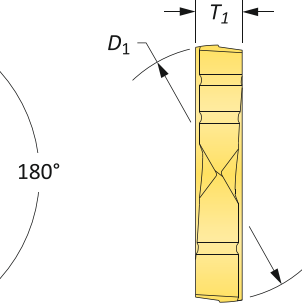
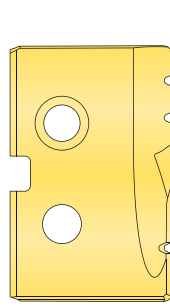

Flat Bottom

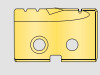

HSS Inserts – Super Cobalt

| Series | Fractional Equivalent | Insert | | | 90° Spot & Chamfer Part No. | | | Flat Bottom Part No. |
|--------|-----------------------|---------------------|-------------------|----------------|--|--|---|--|
| | | D ₁ inch | D ₁ mm | T ₁ |  TiN |  TiAlN |  TiCN |  TiN |
| 1 | 45/64 | 0.7031 | 17.86 | 5/32 | 151T-.703-SP | 151A-.703-SP | 151N-.703-SP | 151T-.703-FB |
| | - | 0.7087 | 18.00 | 5/32 | 151T-18-SP | 151A-18-SP | 151N-18-SP | 151T-18-FB |
| | 23/32 | 0.7188 | 18.26 | 5/32 | 151T-0023-SP | 151A-0023-SP | 151N-0023-SP | 151T-0023-FB |
| | - | 0.7283 | 18.50 | 5/32 | 151T-18.5-SP | 151A-18.5-SP | 151N-18.5-SP | 151T-18.5-FB |
| | 47/64 | 0.7344 | 18.65 | 5/32 | 151T-.734-SP | 151A-.734-SP | 151N-.734-SP | 151T-.734-FB |
| | - | 0.7480 | 19.00 | 5/32 | 151T-19-SP | 151A-19-SP | 151N-19-SP | 151T-19-FB |
| | 3/4 | 0.7500 | 19.05 | 5/32 | 151T-0024-SP | 151A-0024-SP | 151N-0024-SP | 151T-0024-FB |
| | 49/64 | 0.7656 | 19.45 | 5/32 | 151T-.765-SP | 151A-.765-SP | 151N-.765-SP | 151T-.765-FB |
| | - | 0.7677 | 19.50 | 5/32 | 151T-19.5-SP | 151A-19.5-SP | 151N-19.5-SP | 151T-19.5-FB |
| | 25/32 | 0.7813 | 19.84 | 5/32 | 151T-0025-SP | 151A-0025-SP | 151N-0025-SP | 151T-0025-FB |
| | - | 0.7874 | 20.00 | 5/32 | 151T-20-SP | 151A-20-SP | 151N-20-SP | 151T-20-FB |
| | 51/64 | 0.7969 | 20.24 | 5/32 | 151T-.796-SP | 151A-.796-SP | 151N-.796-SP | 151T-.796-FB |
| | - | 0.8010 | 20.34 | 5/32 | 151T-.801-SP | 151A-.801-SP | 151N-.801-SP | 151T-.801-FB |
| | - | 0.8071 | 20.50 | 5/32 | 151T-20.5-SP | 151A-20.5-SP | 151N-20.5-SP | 151T-20.5-FB |
| | 13/16 | 0.8125 | 20.64 | 5/32 | 151T-0026-SP | 151A-0026-SP | 151N-0026-SP | 151T-0026-FB |
| | - | 0.8268 | 21.00 | 5/32 | 151T-21-SP | 151A-21-SP | 151N-21-SP | 151T-21-FB |
| | 27/32 | 0.8438 | 21.43 | 5/32 | 151T-0027-SP | 151A-0027-SP | 151N-0027-SP | 151T-0027-FB |
| - | 0.8465 | 21.50 | 5/32 | 151T-21.5-SP | 151A-21.5-SP | 151N-21.5-SP | 151T-21.5-FB | |
| 1.5 | 55/64 | 0.8594 | 21.83 | 5/32 | 151T-.859-SP | 151A-.859-SP | 151N-.859-SP | 151T-.859-FB |
| | - | 0.8661 | 22.00 | 5/32 | 151T-22-SP | 151A-22-SP | 151N-22-SP | 151T-22-FB |
| | 7/8 | 0.8750 | 22.23 | 5/32 | 151T-0028-SP | 151A-0028-SP | 151N-0028-SP | 151T-0028-FB |
| | - | 0.8858 | 22.50 | 5/32 | 151T-22.5-SP | 151A-22.5-SP | 151N-22.5-SP | 151T-22.5-FB |
| | 57/64 | 0.8906 | 20.62 | 5/32 | 151T-.890-SP | 151A-.890-SP | 151N-.890-SP | 151T-.890-FB |
| | - | 0.9055 | 23.00 | 5/32 | 151T-23-SP | 151A-23-SP | 151N-23-SP | 151T-23-FB |
| | 29/32 | 0.9063 | 23.02 | 5/32 | 151T-0029-SP | 151A-0029-SP | 151N-0029-SP | 151T-0029-FB |
| | 59/64 | 0.9219 | 23.42 | 5/32 | 151T-.921-SP | 151A-.921-SP | 151N-.921-SP | 151T-.921-FB |
| | - | 0.9252 | 23.50 | 5/32 | 151T-23.5-SP | 151A-23.5-SP | 151N-23.5-SP | 151T-23.5-FB |
| | 15/16 | 0.9375 | 23.81 | 5/32 | 151T-0030-SP | 151A-0030-SP | 151N-0030-SP | 151T-0030-FB |
| - | 0.9449 | 24.00 | 5/32 | 151T-24-SP | 151A-24-SP | 151N-24-SP | 151T-24-FB | |

NOTE: 1.5 series inserts fit into both 1 and 1.5 series holders. However, 1 series inserts ONLY fit into 1 series holders. See page A30: 7 for visual.

A30: 112 - 143

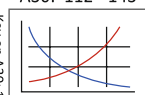

A30: 52 - 56

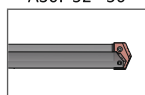

A30: 4 - 6



SW

A30: 4 - 6

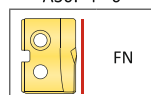

FN

Coatings not listed above can be supplied as non-stocked standards. Process fees apply. →

| | |
|------------------|--------------------|
| TiN = 131T-XXXX | TiAlN = 131A-XXXX |
| TiCN = 131N-XXXX | AM200® = 131H-XXXX |

Inserts sold in quantities of 2